

# SHARPSINKS

A DIVISION OF ESI

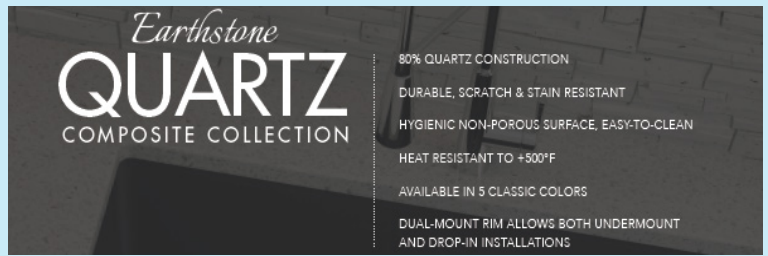

## QSLPV330

80% Quartz Construction

Heat Resistant to +500°F

Durable, Scratch & Stain Resistant

Hygienic, Easy-To-Clean Surface

Dual-Mount Rim

Available in 5 Popular Colors

Includes

Mounting Clips

Paper Template

DXF CAD Files Available

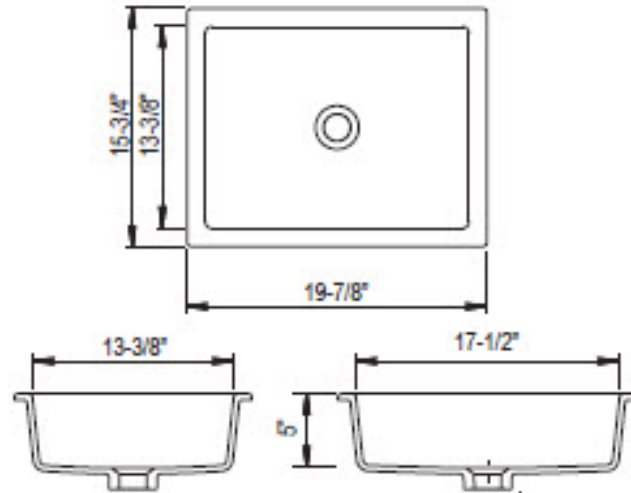

Available Colors: White, Black, Mocha, Concrete & Beige



a J.R. Sharp Company

## SHARPSINKS

A DIVISION OF ESI

800-470-5831

[www.esi4service.com](http://www.esi4service.com)

DALLAS, TX  
DENVER, CO  
LOS ANGELES, CA  
PHOENIX, AZ

SALT LAKE CITY, UT  
SAN FRANCISCO, CA  
SEATTLE, WA  
ST. LOUIS, MO