

SHARPSINKS

A DIVISION OF ESI

DURABLE 18 GA. STAINLESS STEEL
UNBEATABLE VALUE
UNDERMOUNT & DROP-IN OPTIONS
SLEEK MODERN DESIGN
ADA COMPLIANT 18/22 GA. OPTIONS

BUILD SHARP

S340-18

18 Gauge Construction
Undermount
304 Series Stainless Steel
18/8 Chrome-Nickel Content
Fully Insulated Spray Coating
Sound Dampening Pads
Satin Finish
ASME 112.19.3-00
IAPMO/UPC Compliant

Includes
Mounting Clips
Paper Template
DXF CAD Files Available

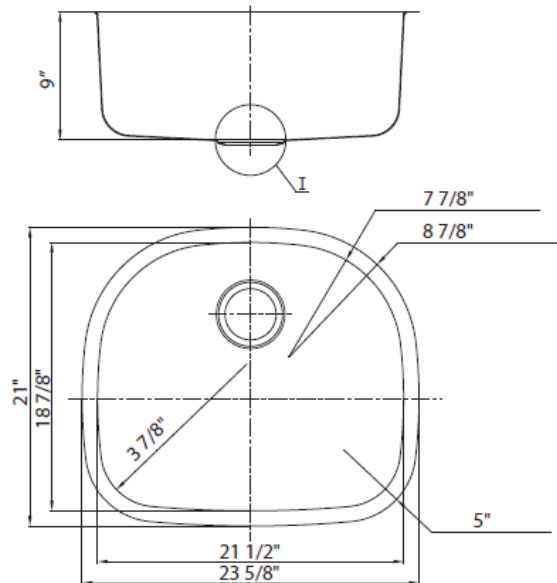

a J.R. Sharp Company

SHARPSINKS

A DIVISION OF ESI

800-470-5831

www.esi4service.com

DALLAS, TX
DENVER, CO
LOS ANGELES, CA
PHOENIX, AZ

SALT LAKE CITY, UT
SAN FRANCISCO, CA
SEATTLE, WA
ST. LOUIS, MO